

Installationsanleitung

LED Stehleuchte
SLMS1, SLMW1, SLMB1

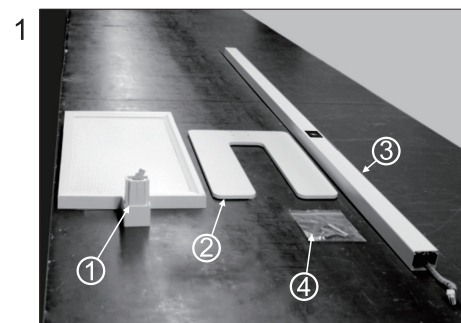

Produkt Liste: ① Leuchtenkopf ② Bodenplatte
③ Stange ④ Zubehör

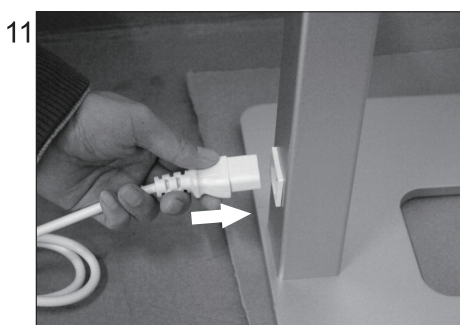
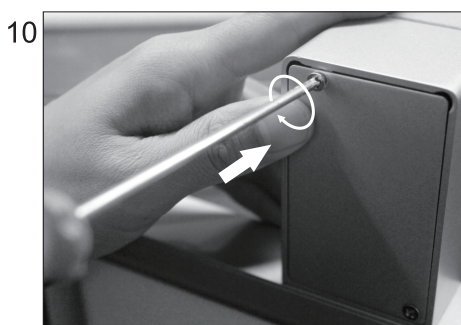
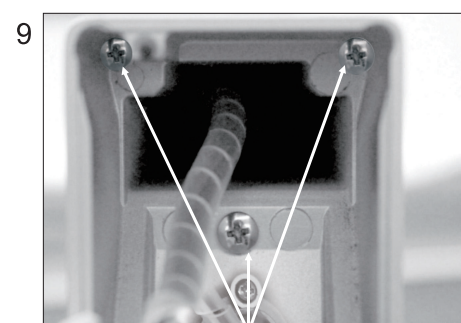
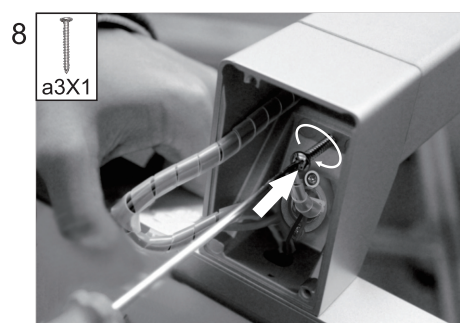
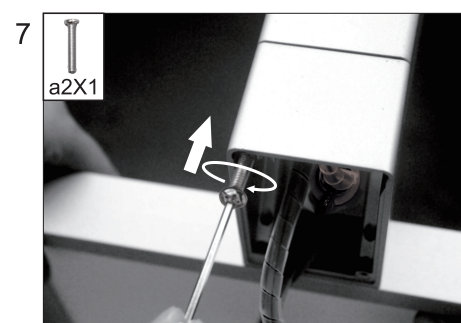
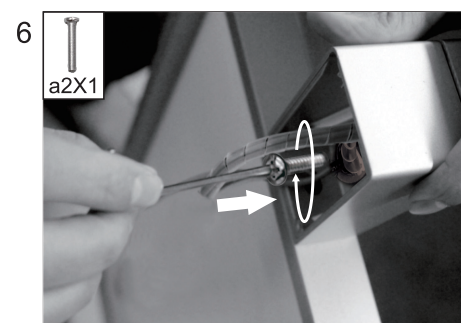
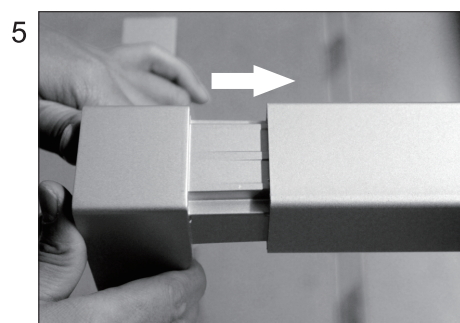
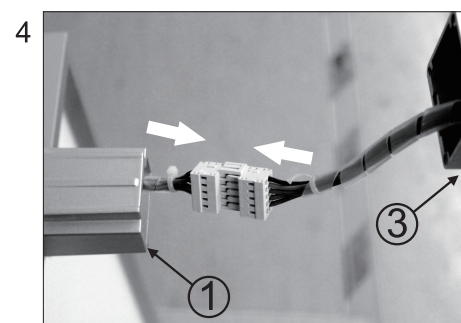
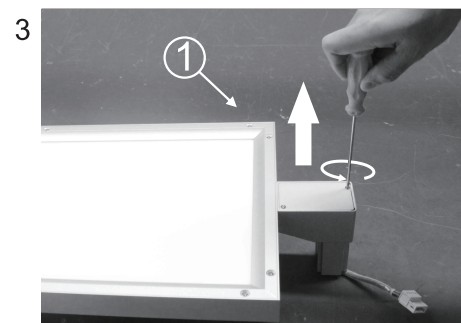
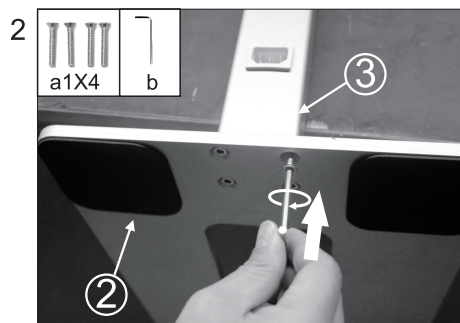

1. Kurz drücken, um das Licht direkt ein- und auszuschalten
2. Zum Dimmern lange drücken



A. Bewegungssensor

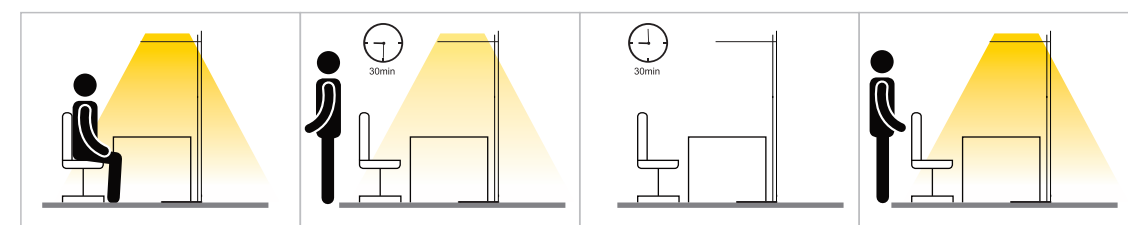

1. Schalten Sie die Lampe ein.
2. Die Lampenhelligkeit wird auf 30% reduziert, wenn innerhalb von 30min keine Bewegung erfolgt.
3. Nach weiteren 30 min schaltet sich die Lampe automatisch aus, wenn keine Bewegung erkannt wird.
4. Die Lampe schaltet sich automatisch ein, sobald eine Bewegung erkannt wird.

B. Tageslichtsensor

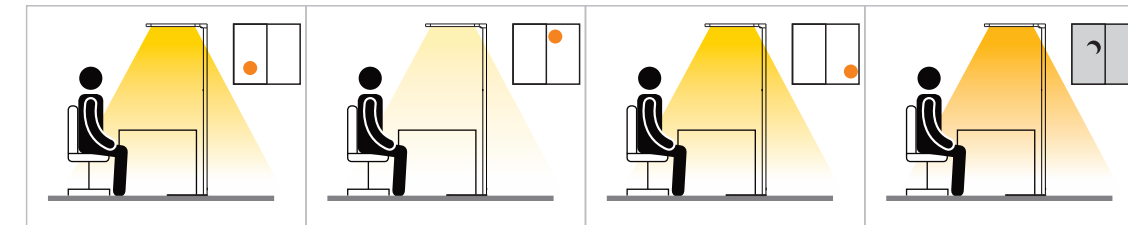

Nach jedem manuellen Einstellen der Helligkeit zeichnet das Steuergerät die vom Sensor erkannte Helligkeit auf und speichert diese bis zum nächsten Dimmen der Helligkeit. (Hinweis: Bitte achten Sie darauf, dass Sie die Lampe auf eine angenehme Lichtstärke einstellen und dimmen) Die Steuereinheit kann die Lichtleistung automatisch entsprechend den Änderungen der Umgebungshelligkeit herunter- oder hochdimmen, um ein relativ konstantes Lichtniveau für einen Schreibtisch in einem Büro zu haben.

Erkennbarer Bereich

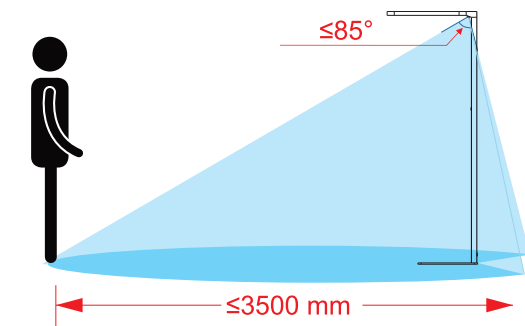

Hier erfahren Sie, wie sie den Bewegungssensor & Tageslichtsensor nutzen können

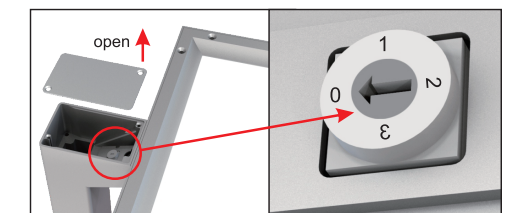

Information	Bewegungssensor	Tageslichtsensor
0	aus	aus
1	ein	aus
2	ein	ein
3	aus	ein

Stellen Sie den Schalter mit einem Schraubendreher auf das gewünschte Modul ein

Importeur:
NCC-Licht
Veit-Stoß-Straße 20
90579 Langenzenn



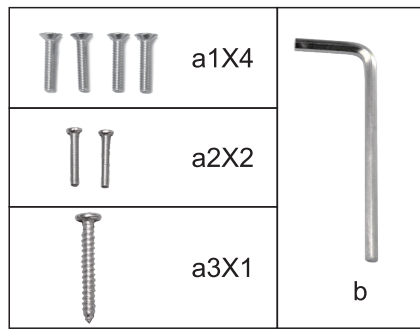

Installation instruction

LED Floor lamp
SLMS1, SLMW1, SLMB1

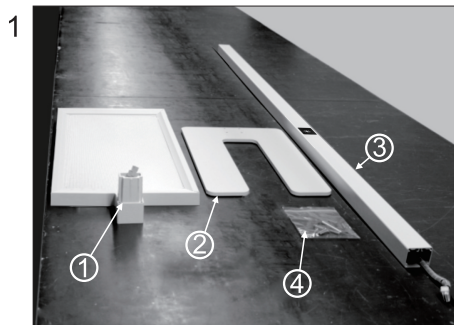

Product list: ① lamp body ② base plate
③ pole ④ accessories bag

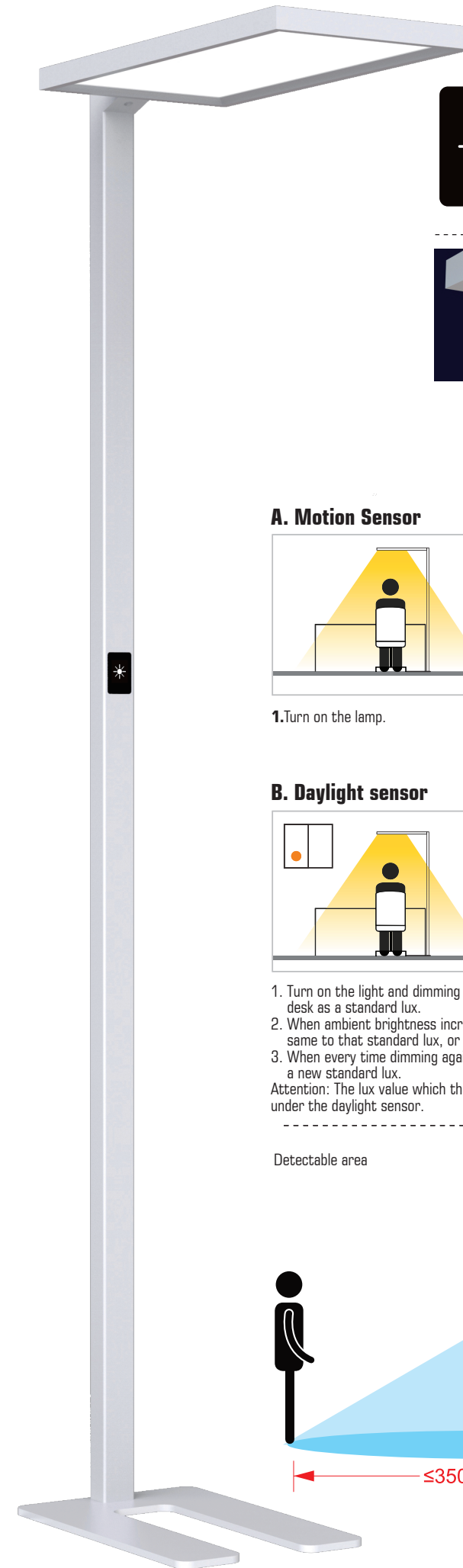
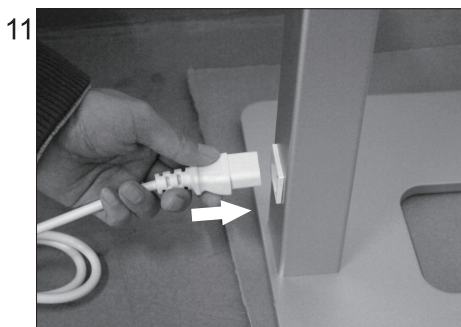
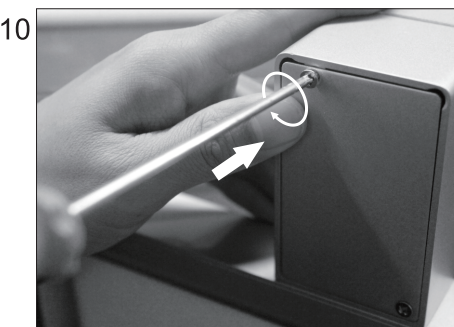
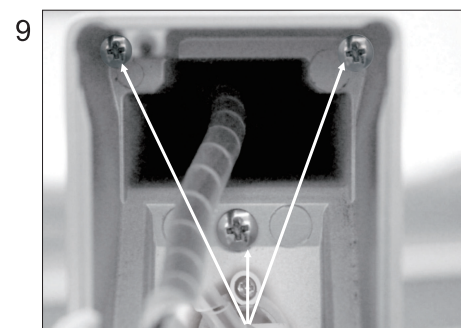
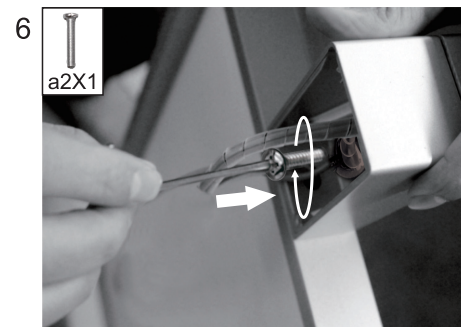
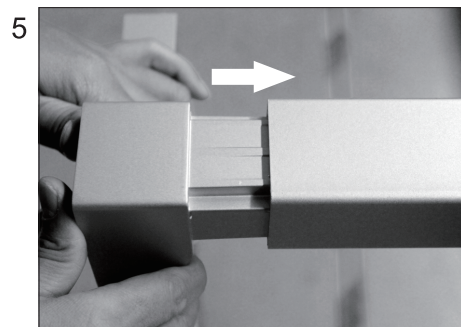
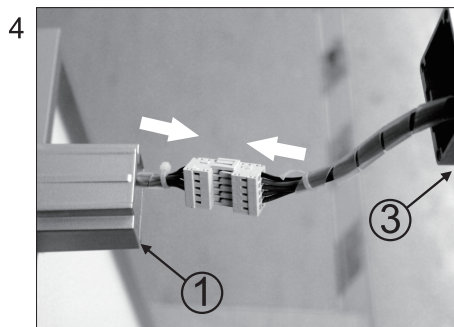
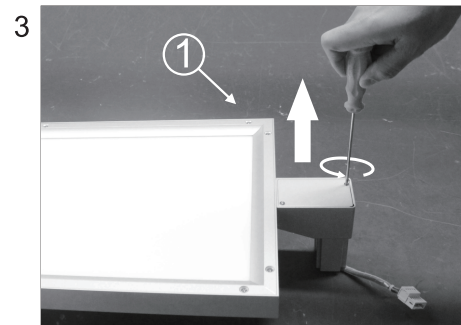
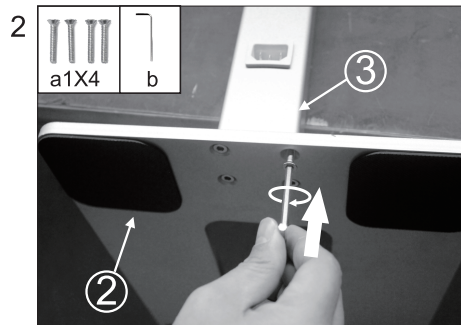

1. Short press to turn off/on.
2. Long press to dimming.



A. Motion Sensor

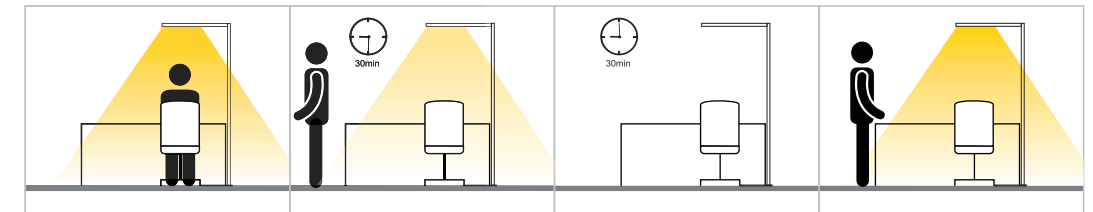

1. Turn on the lamp.
2. The lamp brightness reduce to 30% when there is no presence in 30min.
3. After another 30min, the lamp switches off automatically when still no presence detected.
4. The lamp will switches on automatically at once when there is presence detected.

B. Daylight sensor

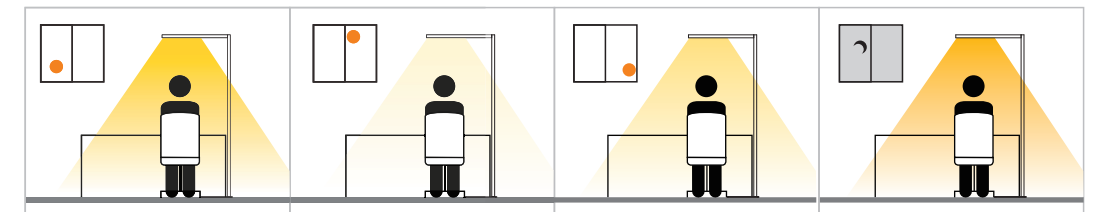

1. Turn on the light and dimming to a comfortable brightness, the daylight sensor will memory this lux value which performance on desk as a standard lux.
 2. When ambient brightness increase (reduce), light will adjust to reduce (increase) its brightness, and guarantee the lux on desk are same to that standard lux, or at least close to that standard lux, it may have around 10% tolerance.
 3. When every time dimming again on light brightness, daylight sensor will memory this new lux value which performance on desk as a new standard lux.
- Attention: The lux value which the light performance on desk will be effected if there is any change on desk within the area of 20° angle under the daylight sensor.

Detectable area

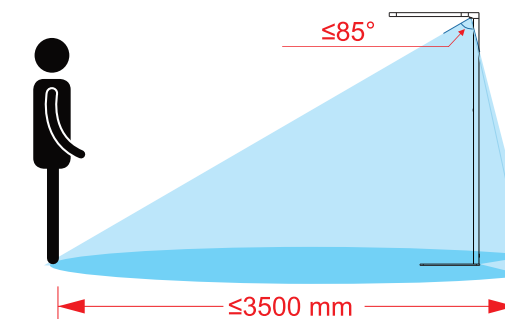

Here to tell you how to play Motion Sensor & Daylight Sensor

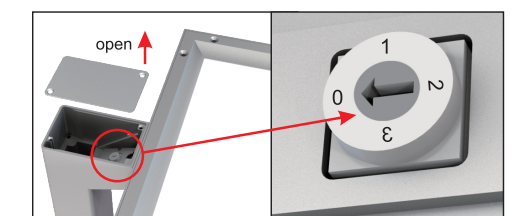

Dip swithes information	Motion sensor	Daylight sensor
0	OFF	OFF
1	ON	OFF
2	ON	ON
3	OFF	ON

Adjust the dip switch to the module by screwdriver.

Importeur:
NCC-Licht
Veit-Stoß-Straße 20
90579 Langenzenn

